

FLEX-LIP® - SHLF Series Dock leveler STANDARD 23" Pit Construction Details

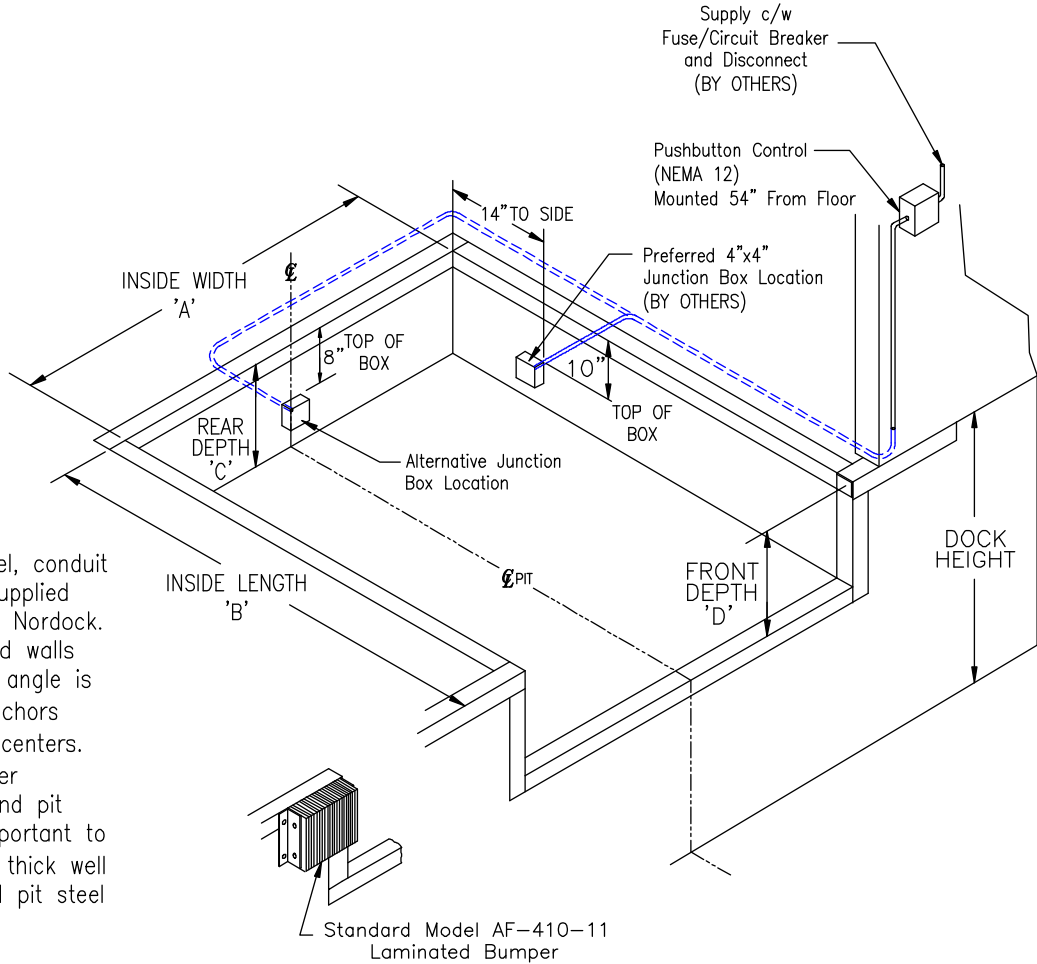

Notes:

All pit construction, pit steel, conduit and bumper anchors are supplied and installed by other than Nordock. Keep all corners square and walls plumb. Recommended curb angle is 3" x 3" x 1/4" with 6" anchors attached on minimum 12" centers. Conduit to be 3/4" diameter terminated at power unit and pit location as shown. It is important to maintain a minimum of 8" thick well vibrated concrete behind all pit steel and down dock face.

Nominal Size	6' x 6'	6.5' x 6'	7' x 6'	6' x 8'	6.5' x 8'	7' x 8'	6' x 10'	6.5' x 10'	7' x 10'
Pit Width 'A'	74"	80"	85"	74"	80"	85"	74"	80"	85"
Pit Length 'B'	63"	63"	63"	87"	87"	87"	111"	111"	111"
* Rear Pit Depth 'C'	* 23-1/2"	* 23-1/2"	* 23-1/2"	* 23-1/2"	* 23-1/2"	* 23-1/2"	* 23-1/2"	* 23-1/2"	* 23-1/2"
* Front Pit Depth 'D'	* 24"	* 24"	* 24"	* 24"	* 24"	* 24"	* 24"	* 24"	* 24"

* Note: Dimensions are for 23" Dockleveler depth. For 19", Refer to form 49-0266.

Model Number Composition: SHLF-(Nominal Size)-(Capacity) (i.e. SHLF-78-35)

Model:							Quantity:
25k	30k	35k	40k	45k	50k	Other: _____	
Lip:	16"	18"	20"	Taper			
Job Reference:							
Location:							

CUSTOMER APPROVAL	
Customer _____	
Approved <input type="checkbox"/>	
Approved as noted <input type="checkbox"/>	
Signature _____	
Position _____	
Date _____	